

PLAN VIEW

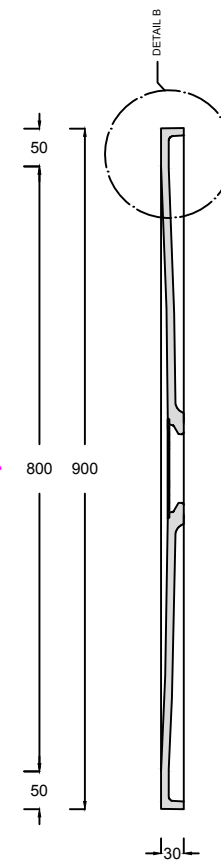

SECTION B:B

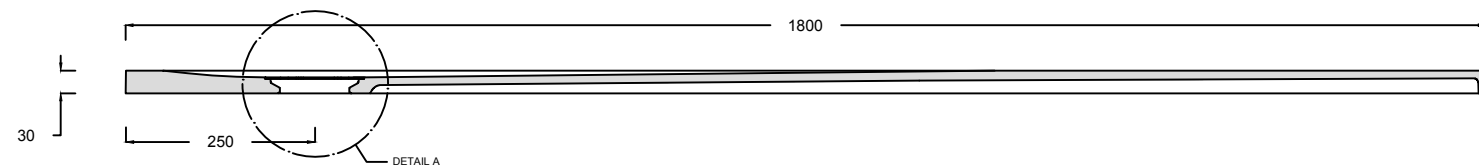

SECTION A:A

All dimensions in mm

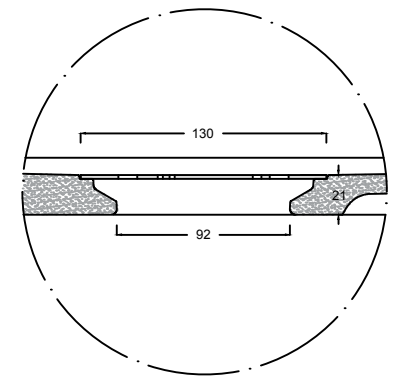

DETAIL A
SCALE: 1:4

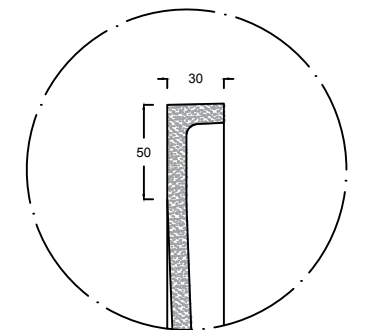

DETAIL B
SCALE: 1:4



Corian.

ARCHIVE NBR: ARCHIVE 3	CUSTOMER NAME:
FILE NAME/FORMAT: DUPONT_CORIAN_SMART8225_2D.DWG	APPLICATION/DESCRIPTION: Bath/ Shower Tray
MODEL NAME: SMART 8225	DOCUMENT STATUS: FINAL
CREATED BY: KS	CODE: D3-8225-02
APPROVED BY:	APPROVAL DATE:
LAUNCH DATE: 01/07/2016	DATE OF ISSUE: 01/07/2016
SCALE: 1:10 in A3	REV. NBR/DATE:

DISCLAIMER/COPYRIGHT:
THIS DRAWING HAS BEEN FURNISHED BY E.I. DU PONT DE NEMOURS AND COMPANY. THE INFORMATION AND KNOW-HOW THEREON MAY NOT BE USED NOR THE DRAWING REPRODUCED WITHOUT THE WRITTEN PERMISSION OF E.I. DU PONT DE NEMOURS AND COMPANY. ALL REPRODUCTIONS IN WHOLE OR IN PART, INCLUDING VENDOR'S SHOP DRAWINGS, SHALL BEAR OR REFER TO THIS STAMP