

TOP VIEW

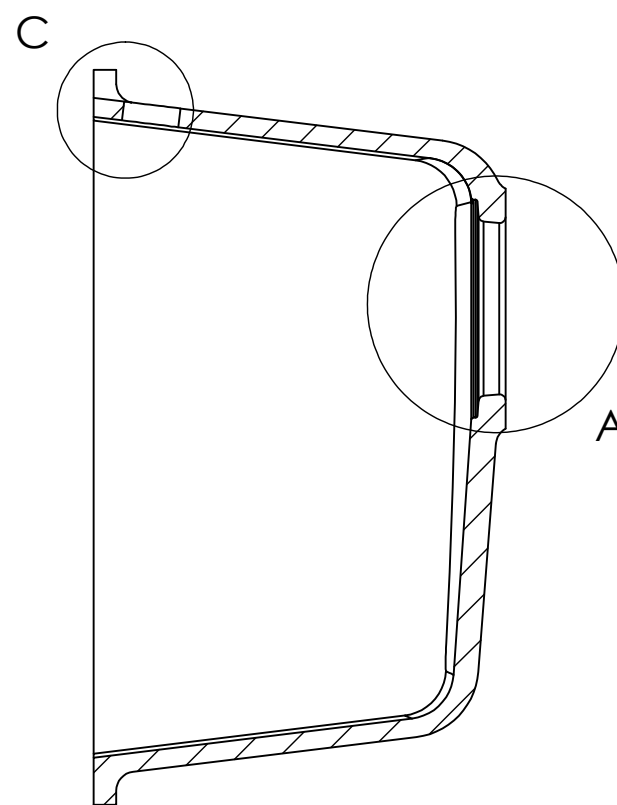

SECTION B-B

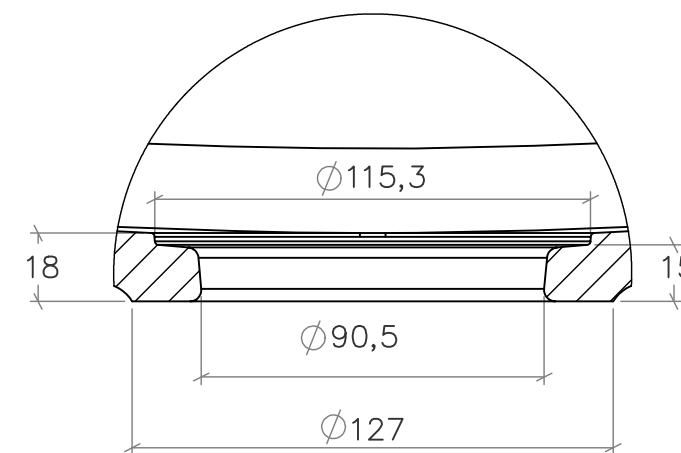

DETAIL A
SCALE 1 : 2

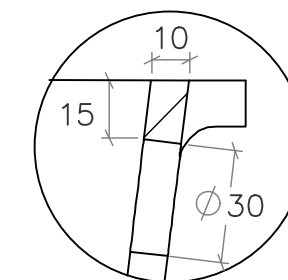

DETAIL C
SCALE 1 : 2

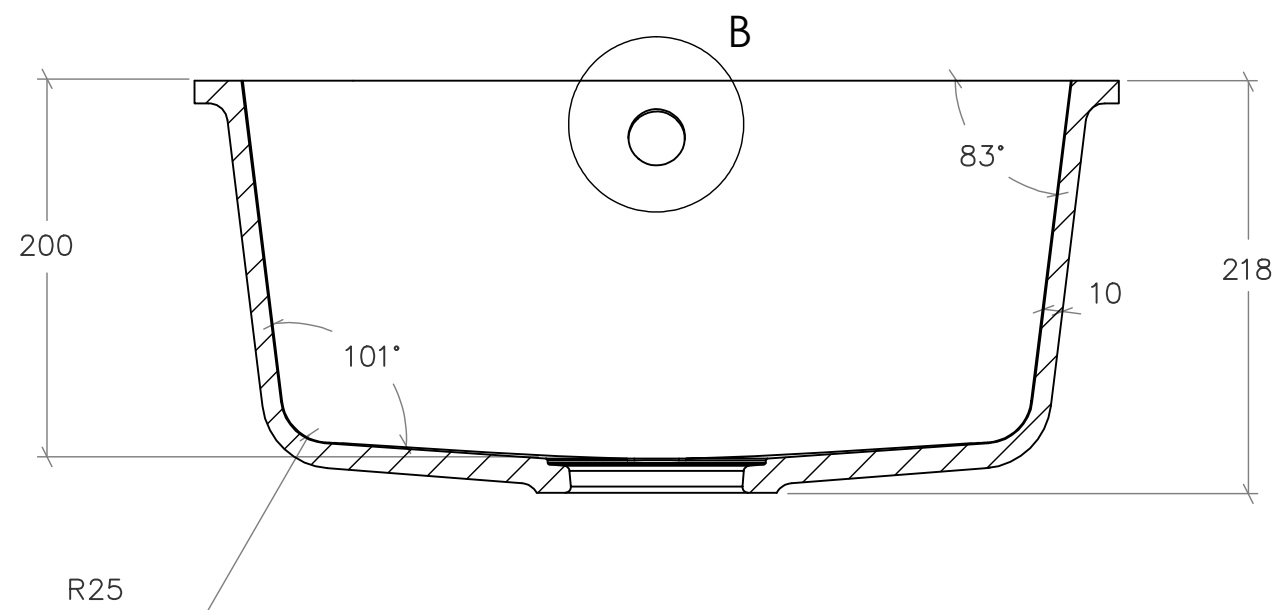

SECTION A-A

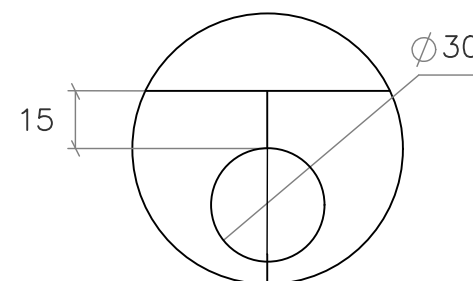

DETAIL B
SCALE 1 : 2



ARCHIVE NBR: ARCHIVE 3	CUSTOMER NAME:
FILE NAME/FORMAT: SWEET 859.DXF	APPLICATION/DESCRIPTION: Kitchen Sink
MODEL NAME: SWEET 859	DOCUMENT STATUS: FINAL
CREATED BY: SD	CODE: D3-810-01
APPROVED BY:	APPROVAL DATE:
LAUNCH DATE:	DATE OF ISSUE: 23-01-2020
SCALE: 1:4 on A3	REV. NBR/DATE: Rev. 03-23/01/2020

DISCLAIMER/COPYRIGHT:
THIS DRAWING HAS BEEN FURNISHED BY DU PONT DE NEMOURS INC. THE INFORMATION AND KNOW-HOW THEREON MAY NOT BE USED NOR THE DRAWING REPRODUCED WITHOUT THE WRITTEN PERMISSION OF DU PONT DE NEMOURS INC. ALL REPRODUCTIONS IN WHOLE OR IN PART, INCLUDING VENDOR'S SHOP DRAWINGS, SHALL BEAR OR REFER TO THIS STAMP